



- Since 1946 -

NORTHWEST DOOR®

THERMA SERIES

Commercial Industrial Garage Doors



Model 308
Manufacturer's Standard White

THERMA SERIES

HEAVY DUTY COMMERCIAL GRADE

MODEL 308 — **R Value 10.4**
 MODEL 308TM — **R Value 12**
 MODEL 650 — **R Value 16**

DOOR SECTIONS:

Door sections are roll formed from hot dipped G-40 galvanized steel and comply with ASTM A653/A653M standards. The sections are sandwich construction type and insulated with expanded polystyrene.

- Model 308, 2" thickness, *R Value 10.4, (RSI-1.8)
- Model 308TM, 2" thickness, *R Value 12, (RSI-2.1)
- Model 650, 3" thickness, *R Value 16, (RSI-2.8)

The door sections are also thermally broken and have a thermal barrier joint seal between door sections. A compressible loop-type PVC bottom weather seal is secured with an extruded aluminum retainer that extends the full width of the bottom of the door. Door widths are available up to 24' 2" and heights up to 16' in three inch increments using 21" and 24" section heights.

Optional 24 gauge steel face, Model 308-24, 308TM-24 and 650-24.

*R Values are calculated specifically for the colder climates and offer the best long term insulating value.

DOOR FINISH:

The door sections have a four-coat protection system:

- (1) galvanizing
- (2) phosphate treatment
- (3) baked on epoxy base coat
- (4) white finish coat

WINDOWS:

Window selection: *(photos on back page)*

- (A) Clear Anodized Full-View Section *(not available on Model 650)*
- (B) PVC Vision Lite **33-1/4"Wx14-1/4"H
- (C) PVC Standard Lite **17-1/4"Wx11-1/4"H
- (D) PVC Security Lite **18-3/4"Wx5-1/2"H.

All windows are standard with 1/8" clear annealed single pane glass. *Optional single pane tempered, textured, colored and insulated glass.*

**Indicates the visible viewing area through the window.

HARDWARE:

Hardware components are hot-dipped galvanized steel with exception of the rollers. All steel components comply with ASTM A653/A653M. Assembled doors meet wind load standards and all specifications established under ANSI/DASMA 102-2011 Garage Door Specifications. Manual push up or chain hoist operation as required by door size.

SPRING ASSEMBLY:

The torsion spring counter balance assembly consists of:

- die cast cable drums
- 1" diameter steel torsion tube or solid shaft
- stranded galvanized aircraft cables with 5:1 safety factor
- minimum 10,000 cycle oil tempered torsion springs, spring wire complies with ASTM A229/A229M-12 specifications

TRACK ASSEMBLY:

Tracks are commercial quality G-60 galvanized steel and comply with ASTM A653 / A653M. Track systems are 2" or 3" in size, 16 gauge to 12 gauge depending on the door size and weight. Vertical tracks are graduated and provide an adjustable wedge-type closing action. Horizontal tracks are reinforced with steel angle of adequate length and gauge to help prevent deflection. Additional field bracing must be provided by the garage door installer to prevent deflection and establish a rigid installation.

CONSTRUCTION:

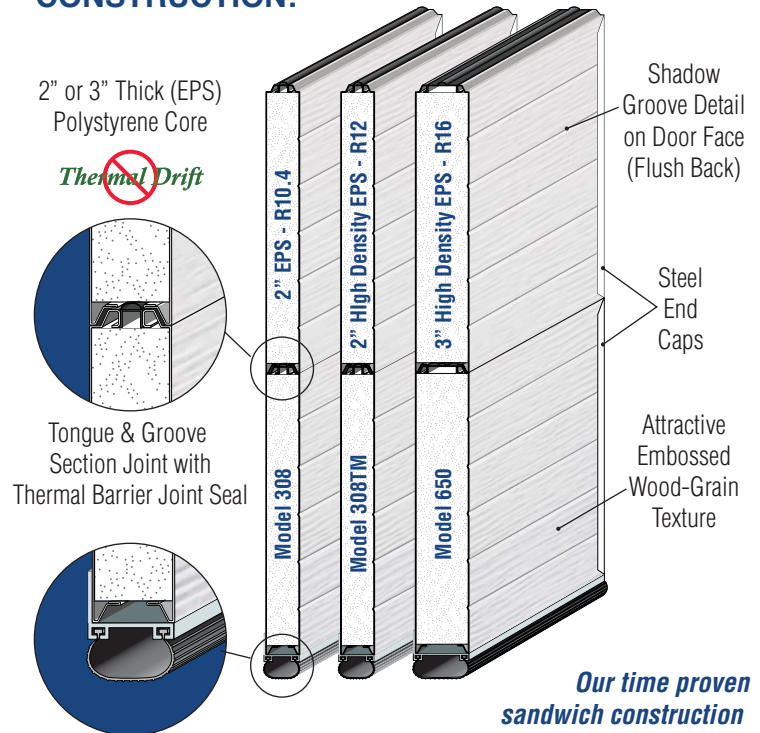

Our time proven sandwich construction method creates a very rigid door and forms a natural thermal-break for additional energy efficiency.

Flexible PVC Weather Seal with Adjustable Aluminum Retainer

	Clearance Requirements	Track Size	Head Room	Side Room	Back Room Depth Into Bldg.
A	Standard Lift	2"	16"	5-1/2"	Door Height+17"
		3"	18"	6"	Door Height+21"
B	Low Head Room Springs to Head	2"	11"	5-1/2"	Door Height+18"
		3"	12"	6"	
C	Low Head Room Springs to Rear	2"	7"	5-1/2"	Door Height+24"
		3"	9-1/2"	6"	
D	Follow Roof Slope	Consult Northwest Door Commercial Design Team 253-375-0729			
E	High Lift Single Incline	2"	High Lift +12"	5-1/2"	Door Height-High Lift+19"
		3"		6"	
F	High Lift Breakaway	2"	High Lift +9"	5-1/2"	Door Height-High Lift+24"
		3"		6"	
G	Vertical Lift Single Incline	2"	Door Height +24"	5-1/2"	14"
		3"		6"	
H	Vertical Lift Breakaway	2"	Door Height +12"	5-1/2"	18"
		3"		6"	

Note: Track and hardware clearances shown are minimums, your installation may vary

EXTENDED LIFE AND HIGH PERFORMANCE PACKAGES AVAILABLE, CONSULT NORTHWEST DOOR

LIFT / TRACK STYLES



Standard Lift Radius

- A -



Low Clearance Double Track Spring Assembly To Head

- B -

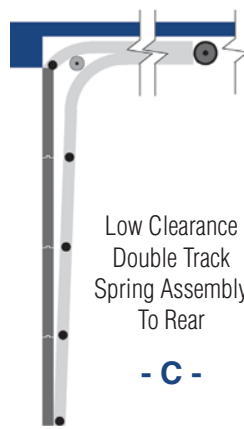

Low Clearance Double Track Spring Assembly To Rear

- C -

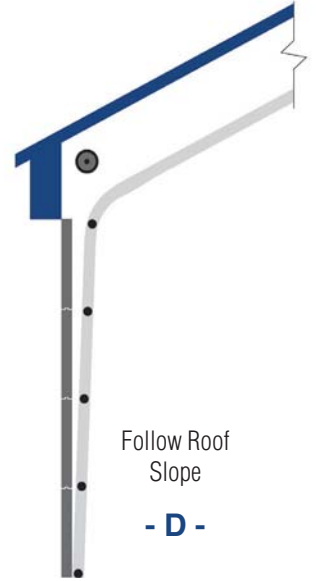

Follow Roof Slope

- D -

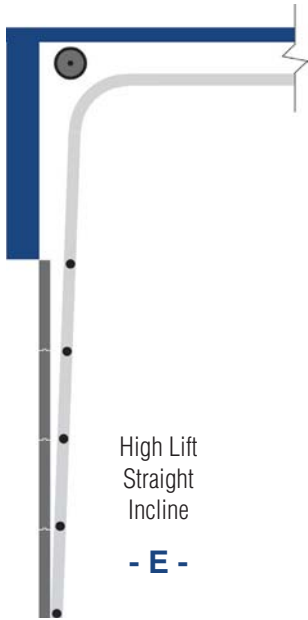

High Lift Straight Incline

- E -

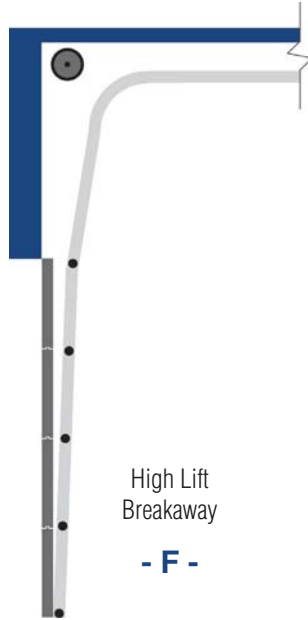

High Lift Breakaway

- F -

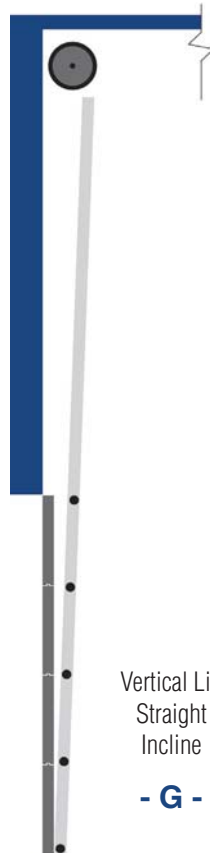

Vertical Lift Straight Incline

- G -

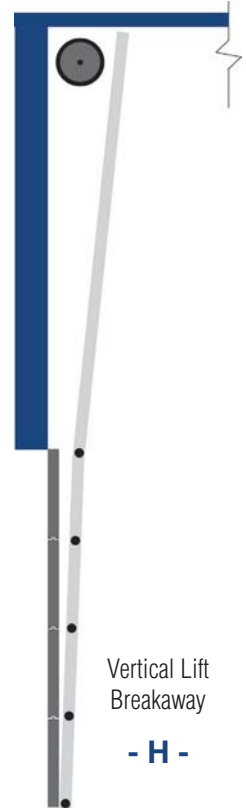

Vertical Lift Breakaway

- H -

MOUNTING TYPES

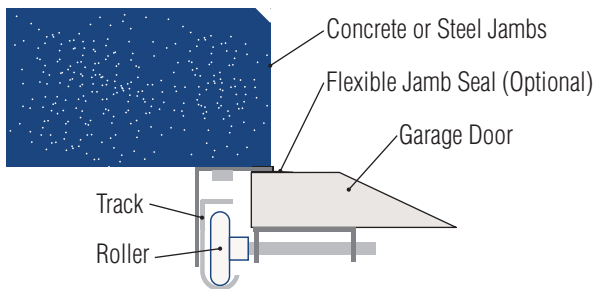

Reverse Angle Mount
Concrete or Steel Jamb

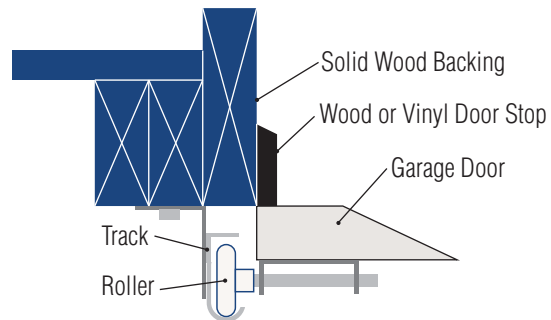

Continuous Angle Mount
Wood Jamb

Door Height	Sections
7'0" - 8'3"	4
8'9" - 10'3"	5
10'6" - 12'2"	6
12'3" - 14'2"	7
14'3" - 16'2"	8
16'3" - 18'2"	9
Door Width	Bays
To - 9'4"	2
9'5" - 12'4"	3
12'5" - 16'4"	4
16'5" - 20'4"	5
20'5" - 24'2"	6

WINDOW TYPES:



- Door Shown with (A) Aluminum Full-View Sections -
Not available on Model 650



(B) Vision Lite



(C) Standard Lite



(D) Security Lite

WARRANTY:

Northwest Door warrants its products to be free of defects in materials for a period of one year after date of shipment from its plant. This warranty is limited to furnishing any part or parts due to product failure during the first year. Northwest Door has sole right to determine whether failure of product is due to product or abuse of product. Warranty does not apply to any product that, in the judgment of Northwest Door, was subjected to misuse or neglect or has been altered during installation in any way that may have impaired its safety, operation or efficiency, nor to any product that has been subjected to an accident. *Contact Northwest Door for complete warranty information.*

WARNING: Any adjustment on your door should be made by an experienced garage door technician such as your Northwest Door dealer. Serious injury can result from improper adjustments to door hardware. Northwest Door reserves the right to make product changes without prior notice.



Model H



Model T

LiftMaster®

Northwest Door recommends LiftMaster® Commercial Garage Door Openers on all Northwest Door commercial garage doors.



NORTHWEST DOOR®
Northwest Door, LLC - 19000 Canyon Road East - Puyallup, WA 98375
800-522-2264 www.northwestdoor.com